

G-ON3

3CH QHD DASH CAM

USER MANUAL



CONTENTS

01. BEFORE USE

IMPORTANT SAFTY	01
INSTRUCTIONS WARNING	
CAUTION FOR MEMORY CARD	02
PRODUCT FEATURES	03
PACKAGE COMPONENTS	04
NAME OF EACH PART	06
SPECIFICATION	08
INSTALLATION	09

02. FUNCTION

HOW TO USE	18
MEMORY CARD VIDEO FOLDER	27

03. APPLICATION

BEFORE WI-FI CONNECTION	29
SMARTPHONE CONNECTION	30

04. withCLOUD

USING 「WITHCLOUD」	33
CONNECTION	34
HOW TO USE 'WITHCLOUD'	37

05. PC VIEWER

PC VIEWER INSTALLATION	39
SCREEN GUIDE	42
QUESTION AND ANSWER	44
TROUBLE SHOOTING	62
WARRANTY CARD	68

IMPORTANT SAFETY INSTRUCTIONS WARNING

© 2021 GNET SYSTEM CO.,LTD. or its subsidiaries All rights reserved. Under the copyright laws, this manual may not be copied, in whole or in part, without the written consent of GNET SYSTEM CO.,LTD. GNET SYSTEM CO.,LTD reserves the right to change or improve its products and to make changes in the content of this manual without obligation to notify any person or organization of such changes or improvements. Go to www.gnetsystem.com for current updates and supplemental information concerning the use of this product.

vGNET® and the GNET logo, are trademarks of GNET SYSTEM CO.,LTD. or its subsidiaries, registered in South Korea and other countries. GNET G-ON™, are trademarks of GNET SYSTEM CO.,LTD. or its subsidiaries. These trademarks may not be used without the express permission of GNET.

microSD® and the microSD logo are trademarks of SD-3C, LLC. Wi-Fi® is a registered mark of Wi-Fi Alliance Corporation.

-
- Do not expose the unit to electrical shock or debris.
 - This may cause product damage, fire, or electrical shock.
 - Avoid use with excessive vehicle window tints or special auto glass.
 - Images may be blurry or distorted and may cause interference with the reception rate of the GPS.
 - Do not modify or dismantle the device/ accessories.
 - We are not responsible for any damage to the device or vehicle due to user tampering.
 - Never operate the device or adjust settings while driving.
 - Always keep your eyes on the road.
 - Do not use liquids or chemicals to clean the product or accessories.
 - This may cause product damage, fire, or electrical shock.
 - Please use a non-scratch lens cloth to clean the product and accessories.
 - Routinely clean camera lens for best results.
 - In the absence of the external GPS, the device's date and time may be reset.
 - Please always check that the date/ time is correct.
 - When parked for long periods of time in direct sunlight, a temperature increase inside the vehicle may result in a memory card corruption and/ or recognition error.
 - It is recommended to remove the memory card and store it out of direct sunlight during long periods of vehicle inactivity.
 - Avoid high temperature or high humidity environment for normal operation of the product.
 - Check the operation of the rear camera(s) periodically before driving.
 - Only the front camera will be captured in the event of a malfunction or defect.

- Overtime, memory degradation can occur and should be replaced periodically.
- To prevent incompatibility problems, please use only a genuine GNET memory card. The GNET memory cards are specifically designed to operate with our GNET systems and are covered under our warranty program.
- When a vehicle accident occurred, it is recommended to remove the memory card from the device and save the data to a computer immediately. When the memory card is full, the data will be overwritten, and the accident data will be lost.
- Please be sure to remove the memory card only after the recording LED is off. Otherwise, if removed too early, video data could be lost or corrupted. This can also shorten the card's lifespan.
- Please do not interchange / swap the memory cards between other products. Data may be erased and lost if the memory card is automatically formatted.
- It is recommended that the memory card be formatted at least twice a month for product and lifespan maintenance. For best results, please use the official SD Formatter (www.sdcard.org).
- GNET System dash cameras can support memory card (SD) capacities ranging from 8GB to 1TB.
- When a new or used memory card is inserted into the device for the first time, the system will go into standby mode for 3 to 5 minutes. Please do not attempt to remove the memory card during standby mode or when the device is formatting the card.
- It is possible to format the memory card in the GNET application for Mac and PC. Please visit the GNET SYSTEM's website at:
<https://www.gnetsystem.com/eng> → SUPPORT → DOWNLOAD



Real HDR



**SONY STARVIS
Image Sensor**



**3CH
QHD/FHD/FHD**



H.265 CODEC



**Interior Camera
Wide Viewing Angle**



**SD Locks for
memory protection**



**G-NET
Wi-Fi APP**



CLOUD System



LBP

• Basic Components



Main Camera



Rear & Interior Camera



User Manual



Interior Camera connection cable



Hardwire Kit



Screw, Wrench



Micro SD Memory card



Rear Camera connection cable



Seal Cable



Tamper-proof Cover



Wi-Fi dongle



External GPS

• Optional Product



Cigarette lighter power cable



OBD power cable

! Cigarette lighter and OBD power cables are each sold separately.

※ The size and appearance of the components depicted above may be different from the real components.

※ Specifications and components may be changed without notice for quality assurance.

※ We highly recommend that a GNET Genuine Memory Card be used with all GNET products.

- **G-ON3T1 for Truck**



Main Camera



Interior & Waterproof Camera

- **G-ON3T2 for Truck**



Main Camera



Waterproof Camera x 2

- **G-ON3B for Bus**



Main Camera



Interior Camera x 2

NAME OF EACH PART

01. BEFORE USE

• Front Camera

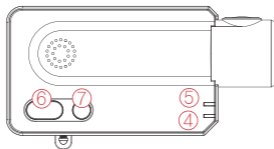
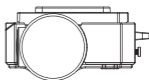
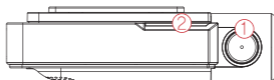
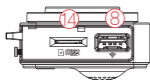
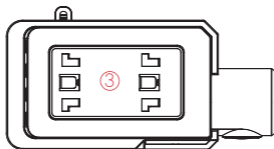
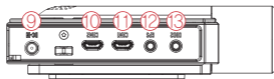

- ① Front Cam Lens
- ② Security LED
- ③ Front Cam bracket
- ④ GPS LED
- ⑤ REC LED

- ⑥ Wi-Fi Connection button
- ⑦ Power Button
- ⑧ Wi-Fi USB dongle Port
- ⑨ Power Connector Port (DC-IN)
- ⑩ Interior Cam Connector Port

- ⑪ Rear Cam Connector Port
- ⑫ External GPS Connector Port
- ⑬ OBD2 Connector Port
- ⑭ Micro SD card Slot

• Rear Camera

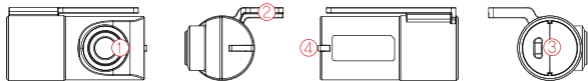

- ① Cam Lens ② Rear Cam Mount ③ Rear Cam Connector Port ④ Status LED

• Interior Camera

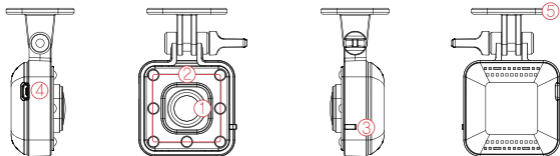

- ① Cam Lens ② IR LED ③ Status LED ④ Interior Cam Connector Port ⑤ Bracket

• Waterproof Camera

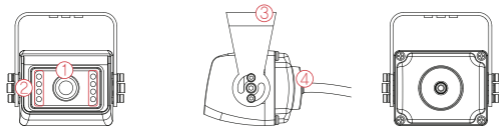

- ① Cam Lens ② IR LED ③ Bracket ④ Waterproof Cam Cable

Image Sensor	SONY STARVIS
Audio input	Built-in Microphone
Video Compression	H.265
Audio Compression	ADPCM
Resolution	Front : QHD(2560x1440)/ Rear, Interior, Waterproof : FHD(1920x1080)
Frame Rate	All cameras : Max. 30 FPS
Recording Time(Approx.)	32GB: 2hrs 50mins / 64GB: 5hrs 40mins / 128GB: 11hrs 20mins 256GB: 22hrs 40mins
3G/4G/Router (Optional)	Connect to with CLOUD via 3G/ 4G/ Router telecommunication
Wi-Fi (Optional)	Connect to GNET Smart phone application via Wi-fi dongle
G-Sensor	Event recording by External Shock
Speaker	Operation Status alarm / Voice guidance
External GPS	Synched with Google map, Keep track of location and Speed
Angle Of View	Front : 140°, Interior : 180°, Rear & Waterproof : 140°
Viewer	Windows XP/7/8/10, Mac, Support 32Bit/ 64Bit, Synchronizing Google map with PC viewer is supported for Windows7 and explorer 10 as per Google's policy.
Power	DC 12V - 24V
Allowable current of providing fuse	3A
Operation Temperature	-20°C ~ 60°C
Humidity	10~95%
Dimension (WxHxD, mm)	Front: 116x56x32, Interior:48x73x26, Rear: 44x38x28 Waterproof: 45x45x35

※ Specifications and components are subject to change without notice for quality assurance.

• How to Install Dashcam

- 1** Assemble the front camera with the provided bracket in the order displayed. Make sure bracket is hooked correctly. Push and align it until a sound is heard. (①,②).

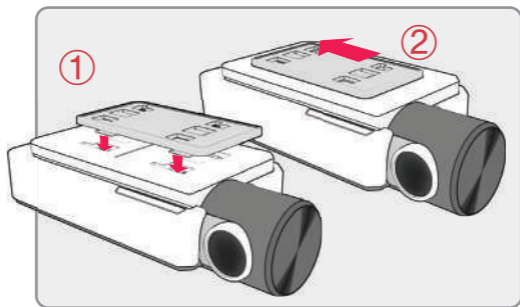

-
- 2** Once the bracket is secure, ensure that the memory card has been inserted. Proceed to peel the cover from the double sided tape on the bracket.

- 3** Install the front camera onto the front windshield of the vehicle making sure the angle and location is properly aligned.

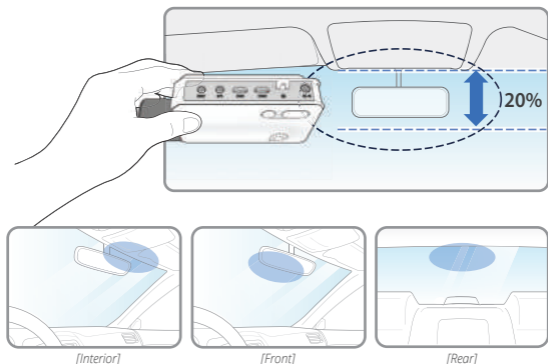

TIP: The adhesive is extremely sticky. Avoid touching the adhesive to the windshield until the mount is properly positioned and aligned.

- 4** Depending on the vehicle, the front angle may be different. It is recommend to hold a dash cam vertically based on a regular passenger car.

- 5** Connect the power cable to the fuse box terminal inside the vehicle.
 (The connected terminal should be one which is always supplied power even when ACC power is turned off, such as emergency lights and/ or door racks.)
 Otherwise if using a cigar power cable, plug it directly into the vehicle cigar socket.

3-Wire Power Cable

- Connect **VCC** to current fuse at vehicle start-off
- Connect **ACC** to a fuse that does not flow when the vehicle is switched off
- Connect **GND** to ground on the vehicle's body

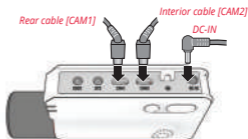
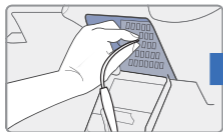

⚠ CAUTION

GNET strongly recommends having an experienced installer with the proper knowledge of electrical systems install the device. Incorrectly wiring the power cable can result in damage to the vehicle or the battery and can cause bodily injury.

- 6** Connect the other side of the power cable to the DC-IN labeled slot of the front camera.

- 7** Attach the rear camera to the rear windshield of the vehicle and connect the cable to the front camera.

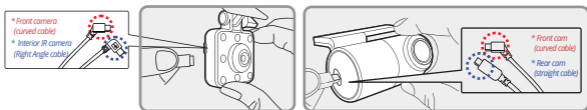

WARNING

When the cable is bent as shown in the picture, the data flow may be interrupted and a recording error may occur. Please be careful.

- 8** Carefully tuck the power cable and rear camera connection cable into the linings of the vehicle between the ceiling and glass.

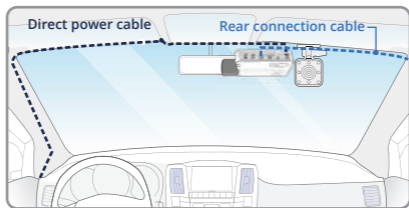

⚠ CAUTION

GPS reception and terrestrial digital sensitivity may decrease depending on the navigation installed. When installing power cables and rear camera access cables, it is recommended that each cable be installed on the opposite side. For example, install the power cable facing the driver's side and the rear camera access cable facing the opposite seat.

• How to Install Fuse Cable

Please refer to the car manual because the fuse box is differ depending on car model.
It is recommended that install the power from the automobile shop.
We are not responsible for any damage caused by self-installation.

1 Find the Fuse box using electric tester from fuse box of the vehicle.

- ※ [VCC] (Yellow line) : When the car is off, it connects with fuse that current is flowing
- ※ [ACC] (Red line) : When the car is off, it connects with fuse that current does not flow

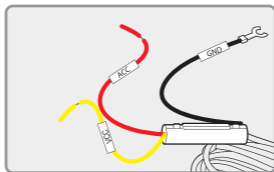

2 After connecting [VCC], [ACC] on vehicle fuse, put them into the Fuse box

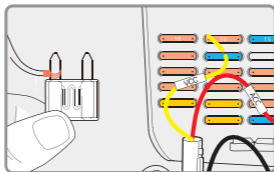

- 3** Connect [GND] line to vehicle
(Do not connect the volt which is connected to dash board. Current is not flowing)

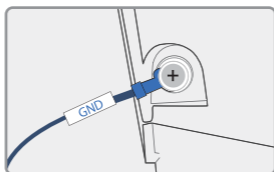

- 4** Connect the power cable to confirm the operation of product.
And organize cables to finish installation work

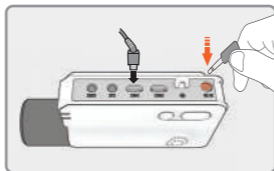

- Inserting the Memory Card

ⓘ Please be fully aware of the orientation of the Micro SD Memory Card.

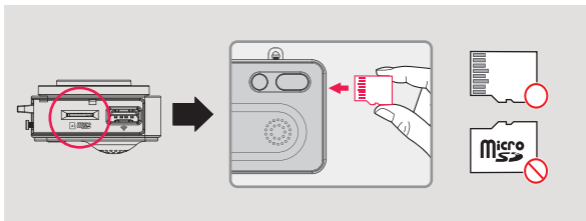

- Push the Micro SD Memory card into the memory card slot until you hear 'click' sound.
- When using memory card for the first time or when the memory card is reused after format, the system will be in stand-by mode for 3~5 minutes to create system files and checking the memory card.
- Recording starts with voice guidance saying "Start recording"

• Tamper-Proof Cover Installation

- 1** Insert a micro SD card in ① and connect the power cable to ②, then slide the SD cover into the hole as shown.

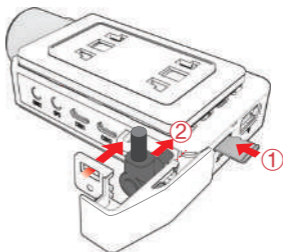

- 2** Fasten a screw firmly to put them together.

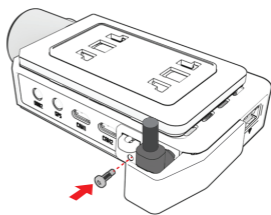

• Seal Cable Installation

- 1 Hook up the cable to the protrusion on the body.



- 2 Bend and insert the end of the cable into the hole to lock it and adjust the length as required.

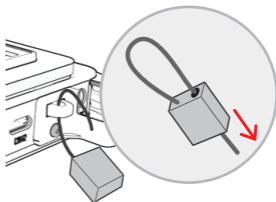

• Product Operation

<p>POWER ON</p>	<p>All LED will be turned on when the engine is on or power is on. "Start recording" starts along with voice guidance and REC LED is turned on. External GPS LED will be turned off if it is not connected by external GPS</p>
<p>POWER OFF</p>	<p>All LED will be turned off when press the power button or constant cable is disconnected.</p>
<p>EXTERNAL GPS</p>	<p>GPS LED will flicker during GPS connection. When GPS connection is completed, GPS LED will be on. Please check the connection again if GPS LED does not turn on while external GPS is connected.</p>
<p>VOICE RECORDING ON/OFF</p>	<p>If you press the Wi-Fi button for 2 seconds, the voice recording will be stopped. If press the Wi-Fi button again, the voice recording will start. * Caution: If you press the Wi-Fi button on dashcam over 5 seconds, the dashcam becomes a factory default. So, please do not put it over 5 seconds if you do not want a factory default.</p>
<p>Wi-Fi USER REGISTRATION</p>	<p>If press the Wi - Fi button, the stand-by mode voice guidance will be displayed. If there is no connection for 2 minutes, it will be automatically discontinued. If press the Wi-Fi button again, the voice guidance will be displayed. *Notice : You need to set the CLOUD as "OFF" in viewer only if you want to convert G-SYNCOULD to Wi-Fi APP after you use GSYNCCLOUD APP.</p>

• ADAS Function - Android

Set the ADAS function at the GNET application.

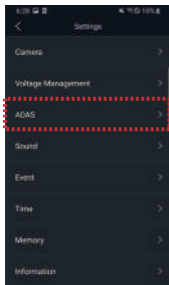

① ADAS ON/OFF :
Turn on/off the ADAS as touching ADAS ON/OFF button.

② LDWS(Lane Departure Warning System) :
When the car leaves the lane, detection alarm will be ringing However, the LDWS will only work if it is above the set speed.

③ FVSA (Front Vehicle Start Alarm) :
Alarm will activate when the stopped front vehicle departs away over 2 meters

④ FCWS (Forward Collision Warning System) :
When the driver approaches very close to front vehicle, the alarm will be ringing

① - ADAS function

② - Lane Departure Warning

③ - Front Vehicle Start Alarm

④ - Forward Collision Warning

⑤ - Lane departure detection sensitivity High >

⑥ - Lane departure detection speed 80km/h >

⑦ - Collision Detection Sensitivity High >

• ADAS Lane correction - Android

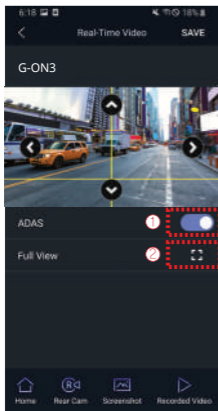

❗ To improve the ADAS recognition rate, it is recommended to adjust the dash camera position by matching the end of the vehicle bonnet line on condition that "the lane correction button" is turned on in the real time screen.

- ① Guideline view on / off
- ② Full screen view (landscape)



- ① Up direction
- ② Left direction
- ③ Right direction
- ④ Downward direction
- ⑤ Exit backward
- ⑥ Save
- ⑦ Guideline view on / off
- ⑧ Screen zoom out

- **Wi-Fi Power On/Off**

The Wi-Fi power is turned on/ off by pressing the Wi-Fi button for 1 second.

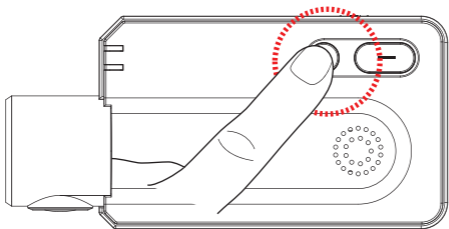

! G-net application and cloud mode are not available while Wi-Fi power cuts.

- **Power On/Off**

Camera power on/off

Press the power button to turn the system off.

To restart the system, press and hold the power button

Wi-Fi power off

The Wi-Fi power will be off when you press the power button for two times

Wi-Fi power on

The Wi-Fi power will be on when you press the power button for two times or press Wi-Fi button for 1 time

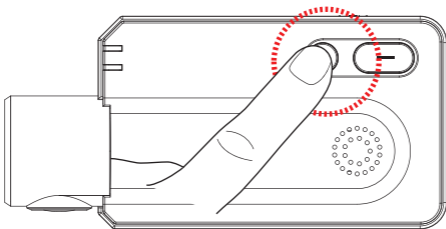

! Pressing and holding the power button also allows you to power off the device. Press and hold the button to start the system back up.

- **Change Into Wi-Fi or Cloud Mode**

The Wi-Fi mode is changed to the CLOUD mode or the CLOUD mode is changed to the Wi-Fi mode if you press the Wi-Fi button for 5-6 seconds.

(At this time, when switching to the Wi-Fi mode or the CLOUD mode, DASHCAM is on and does not reboot)

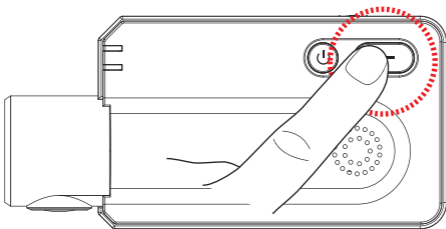

• Recording Mode

Normal Recording		<ul style="list-style-type: none"> - When the power is connected, the normal recording will start. - Security LED flickers left and right every 2 seconds.
Event Recording	Impact Recording	<ul style="list-style-type: none"> - If there is impact or shock, the record LED will flicker and record in event recording mode - After event recording is finished, it will be automatically changed to normal recording mode
	Parking Recording	<ul style="list-style-type: none"> - After the parking mode is entered when the ACC voltage is released, the parking mode automatically operates in 10seconds (3 Wired) - It is recorded in 10 frames, so the recording time can be extended. - Security LED flickers left and right every 4 seconds - If it connects with ACC voltage, it switches to normal recording mode (3 Wired)
	Motion Detection recording	<ul style="list-style-type: none"> - Under parking mode, the device will record any movement happen around 3M. - Security LED will quickly flicker - After motion detection recording is finished, the motion recording will be automatically changed to parking mode

- **Voice Guidance**

CONTENTS	VOICE GUIDANCE
Normal recording	Start recording
System Off	Shut down the system
Overwriting	Recording does not have enough available. Please check overwriting setting.
GPS connection	GPS connected.
Abnormal recording	Video is not being entered.
Enable registration	Stand-by mode for the registration.
Disable registration	Stand-by mode for the registration is released.
Not supported Wi-Fi module	This Wi-Fi module is not supported
No Wi-Fi Dongle	No Wi-Fi Dongle
Complete the smartphone registration	Complete the registration
Already registered smartphone	Already registered smartphone
Connect the Wi-Fi	Users connected.
Disconnect the Wi-Fi	User access disabled.
Connect the playback mode	User's searching starts so, recording is paused.
Disconnect the playback mode	Restart recording.

CONTENTS	VOICE GUIDANCE
Change the Smartphone setting	Setting changed and reboot
Change parking mode to normal recording	Driving mode to start recording. Safe driving
Format the Micro SD memory card	On- formatting the memory card. Please wait
No Mirco SD memory card	No Memory card
Micro SD memory card damage	Memory card is damaged and can not be recorded
Micro SD memory file system recover	Reboot becasue of the damaged memory card. Please repace the memory card if this continues
Update the firmware	On installing the program. Do not turn off the power
Fail to firmware update	Program file is corrupt and can not be installed.
Event recording alarm	Impact event has occurred during parking
LBP ON	Shut down the system to protect the battery of car
LBP OFF	Restart the system to protect the battery of car

- 1** Removing memory card after the device turn off

- 2** Insert the removed memory card into the memory reader and connect it to the USB port of PC

- 3** Select removable disk in explorer folder.
 - Folders in the removable disk are displayed as shown in the following page
 - “Event” folder is created if the event save capacity is setting over 10%.

! Do not randomly delete or format files in memory card.
Backup the important file to PC

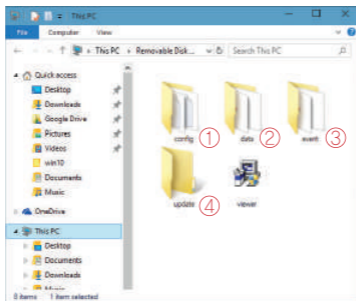

Predictable recording time of SD memory capacity (Default: All cameras : Max. 30 FPS) :

8GB(40mins), 16GB(1.5hrs), 32GB(3hrs), 64GB(6hrs), 128GB(12hrs), 256GB(23hrs), 512GB(46hrs), 1TB(92hrs)

※ Total recording time may be different depending on use conditions and environment.

<p>① Config (Manage system)</p>	<ul style="list-style-type: none"> - Log.txt : It records device's statement as log file - Version.ini : Saving version information of device
<p>② Date (Normal recording)</p>	<ul style="list-style-type: none"> - Recording files are located . File list numbers are different depend on Micro SD memory card's capacity
<p>③ Event (Event recording)</p>	<ul style="list-style-type: none"> - Event data (Impact, Parking, Movement) are located
<p>④ Update (Firmware update)</p>	<ul style="list-style-type: none"> - Locating update file in this folder, the updating will start automatically

- **Download our Smartphone App**

- Available for Android and Apple iOS. Search “GNET” on Google Play and Apple App Store.
- Or simply scan our QR Code



- **Precaution Before Use**

- Set the time zone on the GENT app or the viewer.
- Smartphone make, model, or specification can interfere and delay real time video playback.
- DO NOT operate the device or adjust App settings while driving.
Please always safely pull over when interacting with GNET products.

• How to connect an Apple iOS smartphone

- 1 Install the GNET application on the smartphone.
* G-net application is not available while cloud mode is on.



- 2 Press the Wi-Fi® button on the dash camera to enter standby mode with the voice message "Registration standby mode" (last 2 minutes)

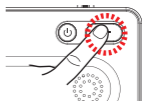

- 3 Enter the Settings menu and proceed to locate and connect to the dash camera's Wi-Fi network (begins with GNET_BB_).



The password is as follows: **qwertyuiop**

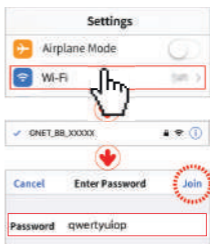

- 4 The registration of the dash camera is completed when you hear "User's connected".

* If the connection fails due to a weak Wi-Fi signal, please carefully unplug and immediately re-insert the Wi-Fi dongle back into the camera. Proceed to try the connection again by pressing the Wi-Fi button to enter standby mode.



• How to connect an Android smartphone

- 1 Install the GNET application on the smartphone.
* G-net application is not available while cloud mode is on.



- 2 Press the Wi-Fi® button on the dash camera to enter standby mode with the voice message "Registration standby mode" (last 2 minutes)

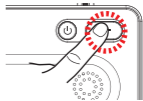

- 3 Touch the "+" to search for your device - use the left and right arrows scroll. Once your device has been located select the "Connect" button.

[★] will indicate first time connection to the device.



- 4 The registration of the dash camera is completed when you hear "User's connected".

* If the connection fails due to a weak Wi-Fi signal, please carefully unplug and immediately re-insert the Wi-Fi dongle back into the camera. Proceed to try the connection again by pressing the Wi-Fi button to enter standby mode.



- GNET Smartphone App

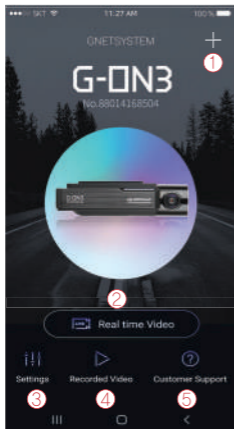

- ① This function allows you to connect other dash cams or delete the registered devices.
* Supported only on Android mobile
- ② **Real-Time Video**
Select this button to view a live video feed from the dash camera.
- ③ **Settings**
You can easily toggle camera settings via your smartphone. When finished, select the "Save" button to reboot the system.
- ④ **Recorded Video**
View previously recorded video from the camera's SD card. Video can be downloaded directly onto the smartphone.
- ⑤ **Customer Support**
Need product support? Select this button to be directed to our customer support center.

Both mobile apps(Android / iOS) and web are available.

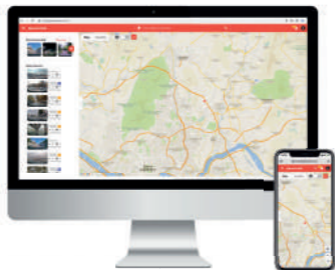

- App



withCLOUD



- Web (You can access it through the address below)

<https://cloud.gnetsystem.com>

Main (PC)



① Menu button

② Location search(Enter City or Address) : The map moves to the area you searched for.

③ Event alarm : It is displayed when an event occurs, and when you press an event in the list, the video is played.

User icon : You can select Channel / Settings / Logout

④ Recommended : The video is recommended in the order of high views and likes.
Press 'View More' to go to the recommended video page.

⑤ Recent videos : The latest shared video will be displayed based on location.

⑥ Show only my vehicle : Function to show only my vehicle on the map. Can set ON/OFF.
Quick menu(My vehicle) : Run basic menus right away without finding a vehicle on the map.
(If there are multiple vehicles, this is the most recently accessed vehicle.)

⑦ Vehicle icon

Other user 's vehicle



My vehicle(Driving)



My vehicle(Parking)



Main (Mobile)



① Menu button

- ② **Event alarm** : It is displayed when an event occurs, and when you press an event in the list, the video is played.

User icon : You can select Channel / Settings / Logout

Location search(Enter City or Address) : The map moves to the area you searched for.

- ③ **Open/fold the side tabs** : Press the button to open and close the left tab.
- ④ **Recommended** : The video is recommended in the order of high views and likes.
Press 'View More' to go to the recommended video page.
- ⑤ **Recent videos** : The latest shared video will be displayed based on location.
- ⑥ **Show only my vehicle** : Function to show only my vehicle on the map. Can set ON/OFF.
Quick menu(My vehicle) : Run basic menus right away without finding a vehicle on the map.
(If there are multiple vehicles, this is the most recently accessed vehicle.)

⑦ Vehicle icon

Other user 's vehicle



My vehicle(Driving)



My vehicle(Parking)



Live video / Recommended

- **Live video**

You can check the real-time image by selecting the vehicle icon of the user who shared your vehicle or location/video on the map.

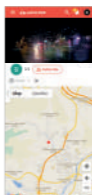
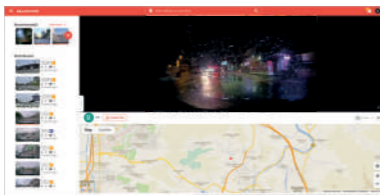

- **Recommended**

The function of recommending videos with high views and likes. If you press "More" in the recommended video on the main screen, it moves.

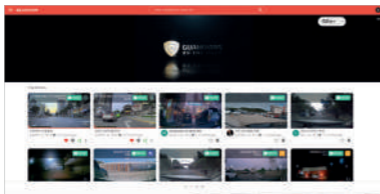

Event videos / Channel

- Event videos

A screen where I collect event videos of my vehicle. You can set up or delete sharing, and search for videos by date/vehicle/event.

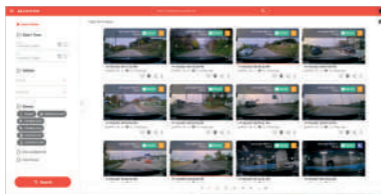

- Channel

You can view the event video shared by the user, the subscription channel, and the shared video that you like.

Live video of my vehicle is displayed at the lower end of the profile area.

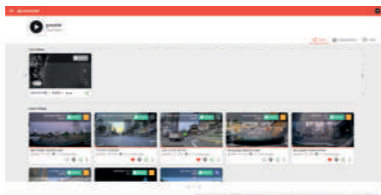

Vehicle management / GPS Tracking

- **Vehicle management**

In the registered vehicle, such as setting the location of my vehicle, setting the black box, and setting the cloud plan, all settings related to it are possible. You can check by selecting the photo/text mode of the list.



- **GPS Tracking**

You can view the driving record of the vehicle by date, vehicle, and section, and an event while driving.

The details are also displayed. If you press the driving history, you can know the driving time, mileage, and departure/arrival time.

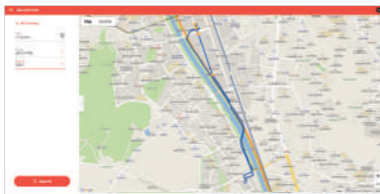

• Install PC Viewer - MAC OS

"PC Viewer-MAC OS" installation program on the Gnet homepage
[Customer Center - Download] Download and use it.

• Install PC Viewer - WINDOW

! The PC specification should be over '**CPU i5 3.0 GHz, Memory 4GB**' to play the Full HD If the PC specification is lower than standard, it is possible to happen "No-play back" or disconnect

1 PC viewer program is not installed in case of first use or when format the memory card.

2 Insert the Micro SD memory card and turn on the device.

3 Depends on the capacity, the recording time will be different. At first use, take 3~5 minutes to initialize and create the file system (All LED flicker while initializing. After it starts recording, REC LED will turn on) Therefore do not turn off the power

4 Insert the Micro SD memory card to PC

• Install PC Viewer - WINDOW

- 5 Install the [Viewer.exe] file in the Micro SD memory card as picture shown.

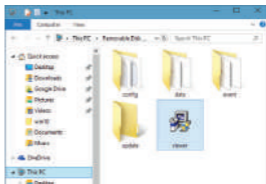

- 6 Click the [YES] button on the user control menu.

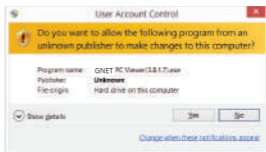

- 7 Click the [Next] button and click the [Installation] button

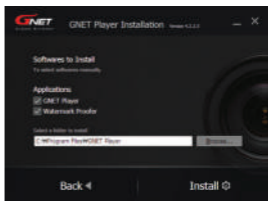

• Install PC Viewer - WINDOW

- 8** Confirmation the latest version pop-up will appears as picture shown if network is connected. If there is no internet connection, PC Viewer program will be executed directly.



- 9** Click the [Execute a viewer] button to start viewer program.

- 10** When the installation is completed, the PC Viewer program runs automatically and Gnet icon will be created on the computer.



- 11** [Open the file]

When click the file button(), the browse folder will appear like picture. And select removable disk, Press [OK] button.

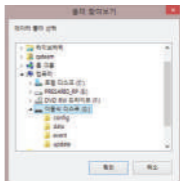

• PC Viewer - WINDOW



① Tool Box Save Folder Open Print Setting

② Google Map (When GPS and internet are connected, it will work normally)

③ Playlists and Information Display

④ GPS reception window
(It can be used only when an external GPS is connected)

⑤ Video control popup

	Thumbnail
	Draw a lane
	View a video
	Split View
	PIP View
	Toggle (change) color, black and white mode

⑥ G-sensor (acceleration) graph

⑦ Speedometer
(It can be used only when an external GPS is connected)

⑧ Play a recorded video

	Reverse and forward play
	Pause
	Repeat event video
	Previous, Next Event
	Play one frame

⑨ Adjust playback speed

⑩ Sound control

• How to Check G-sensor data

When you play the video, three-dimensional coordinate system information (G-sensor data) on the X-axis(progress direction), Y-axis (left-right), and Z-axis (height) of the image currently being played at the G-sensor data location is output.



<Magnification of G-sensor data>

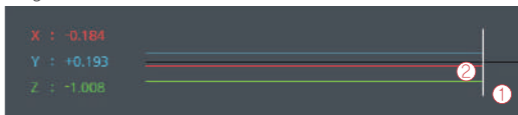

- ① The location of the image currently being played
- ② Numerical values and graphs of three-dimensional coordinate system information (G-sensor data)

Q

Hearing “Ding-Dong” sound come from dash cam while driving.

A

A impact detection sensor inside dash cam detects impact or when dash cam detect curve while driving, there is buzzer sound like Ding-dong with frequent LED blinking. It means that dash cam is correctly working.

If the sound from device bothers you, you can configure sound and buzzer to turn on/off via dedicated viewer.

Q

When user realize out of focus video recorded from own dash cam.

A

The focus out problem is caused by misplace when use install it, even if it is not lens faulty. So, please make sure dash cam is installed in over exposed location windshield. Please kindly move camera's position and try to check video again.

Before installing dash cam, user need to clean car's wind screen in case of getting blurry video quality from dust, excessive tinting and back light.

If it doesn't work after you take all the solution, please contact your seller or manufacture by sending video including problem.

Q

Is dash cam available for a tinted car?

A

Heavy tinting of windshield may influence video quality. The video quality gets too dark. For this case, we recommend that user remove tinting on where dash cam is installed.

Q

Parking mode work in curve or slope on the road.

A

To switch into parking mode, dash cam need to have those information such as migratory routs, horizontal angle of car. But, if your car is parked on slope, dash cam may not be recognized that car is not stopped.

So, your vehicles maintains an angle more that specified value, dash cam may misunderstand that some events are occurred.

Q

GPS signal reception does not work well.

A

For your information, GPS must be away from dash cam due to interruption of GPS reception inside a car. If you install dash cam behind mirror on front, external GPS antenna is suggested to place upper left and right side.

Q

How to set Date and time through dedicated viewer.

A

Please insert memory card onto your PC. And, open dedicated PC viewer. Select right time zone and time at system section in setting. Please save it when you close viewer. Once all that is done, please insert your memory card back to camera and start it again. The setting is done in few second as your configuration.

Q

If dash cam is connected with constant power cable, is the car battery discharged at all?

A

Our dash cam has a function that it is automatically power off when dash cam detects below voltage value from car's engine. We can say that our dash cam is fully working against discharge of car battery. But, please be informed that car battery may get discharged depend on battery condition and cold temperature in winter season according to its nature. So, if your battery has been using more than 2~3 years, please replace car battery for safety usage.

Q

My car is discharged, even if I installed dash cam as constant power cable connection.

A

First of all, you need to make sure that your connection of fuse cable is properly installed as per instruction. Personal user may be not familiar with hard wire compared with cigar jack cable. ACC(Red) need to be connected to a fuse which is powered when car engine is on. VCC(=B+)(Yellow) need to be connected to a fuse which maintain power even if car engine is off. GND(Black) should be connected to a volt which is physically contacted to metal surface around fuse box. And, you need to check battery life. Deteriorated battery affects battery shortage. If the problem is existed even after your test by using two methods, please contact to your seller or manufacture customer service center.

Q

Is dash cam used with AC adapter?

A

Our products are only for car and it is not available to use with AC adapter.

Q

Dash cam is suddenly power off while driving.

A

Users who are using dash cam with constant power cable often trouble with this kind of issue. This problem is considered that dash cam take over voltage from car battery. Especially in winter season, there is more chance for discharge as frequently using heater, extended usage time of head lamp, fog light and navigation.

Q

Noises in recording sound.

A

Dash cam is recording any sound in car by amplifying sound for clear recording. Even if there is no sound around camera, low noise may be recorded in recording sound. Please be aware that it is normally working. If you can not recognize sound for recording due to noise, you need to contact seller and manufacture shortly.

Q

Dash cam is turn on at all.

A

[Using Cigar jack Cigarette cable]

- a. Please make sure if cigar jack cable is correctly working or not.
- b. Confirm that power socket of cigar cable is correctly connected.
- c. Please check cigar jack is correctly placed on AC terminal.
- d. If dash cam doesn't work after firmware update, it is caused by update failure which case need to be sent to customer service center.

[Using Fuse cable/ OBD power cable]

- a. If input voltage goes down below LBP(lower battery protection) value setting, dash cam interrupt power itself to protect car's battery.
 - b. Please check dash cam operation after turn on car and charge car battery.
-

Q

Voice is not recorded.

A

If the voice recording function is released by dedicated viewer by user, voice recording does not work. Or In case it is LCD model, if user press mode button shortly via LCD panel, user may turn voice recording on/off. Sometime, user mistakenly press mode button via dash cam, voice recording is off even though, this set is on through PC viewer. So, please make it on via dash cam as pressing mode button shortly if you need voice recording.

Q

Why user should use genuine memory card.

A

Every memory card from each manufacture has different NAND flash and internal controller. Our genuine memory card has been tested for long time in multiple test environments. Also, genuine memory card shows the best compatibility with our products. Memory card is very important storage device and must have solidity to endure reading / writing data in every few seconds during operation. If you use dash cam with other brand memory card, we cannot guarantee proper working and warranty service.

Q

Keep repeating Voice from camera.

A

If you have a problem with keeping repeating voice guidance, you need to check SD card whether it is faulty our not. So, take out memory card and insert onto PC to format SD card. For safety of device, user should check memory card every two weeks.



How to use products stably.



1. Swipe dash cam lens regularly. Fingerprint and dust on lens are one of issue to make Blurred video quality.
2. Please check if you dash cam is properly working or not. It may not correctly work from errors such as memory card faulty and poor contact of cigar jack.
3. If user use constant power cable, please check and format the memory card once in a week.
 - Basically, our products support format -free function for user's convenience. But, it may strain for memory card while it is reading / writing. Also, the files in memory card get failure by excessive work.
4. Please separate power jack when you do not use car for long time.
 - The trickle consumption even if car engine is off from car battery will cause out of battery sometime.



How long is the warranty period?



The warranty period for GNET Dash camera is one year from the date of purchase.

※ The warranty period for accessories and Micro SD card : 3 months

WARRANTY CARD

Product	GNET Dash cam		Model	G-ON3
Serial Number			Purchasing Date	
Consumer Information	Name		Tel	
	Address			
Seller / Vendor			Tel	
Warranty Period	Dash Camera : 1 Year Micro SD card : 3 months			

Q What is the password of Wi-Fi ?

- A**
1. Turn on Wi-Fi function of smartphone
 2. Select the "GNET_BB_XXXX" in the list
 3. Write [qwertyuiop] in the password blank and touch the join button.
 4. Press the Wi-Fi registration button of the dash camera

Cancel	Enter Password	Join
Password	qwertyuiop	

* Caution: If you press the Registration waiting button(WI-FI button) on dashcam over 10 seconds, the dashcam becomes a factory default. So, pls do not put it over 10 seconds if you do not want a default.

Q Where is the saved when I save the dash camera video on my smartphone?

A It is different system depends on the manufacture.

- A. Samsung : My file → Device Internal storage → DCIM → GNET
 - B. LG : File management → All files (or Internal storage → DCIM → GNET)
 - C. I-phone : Camera roll(in the picture app)
- If you can not find the files, Search for "DCIM" folder on your smartphone

Q

Where can I download the GNET PC Viewer?

A

Dash camera will automatically save the viewer program installation file in the Micro SD Card when it is first booted (when a formatted SD card is loaded).

- (1) When first use, insert the GNET Micro SD card to front camera
- (2) And connect the power cable
- (3) Takes 3-5 min to initialize and create the file system when first use.
- (4) After finished, insert the GNET Micro SD card into the PC
- (5) Run the "GNET PC VIEWER. EXE" program which is saved.
- (6) When the installation is completed, the program runs automatically and GNET icon will be created on your PC.

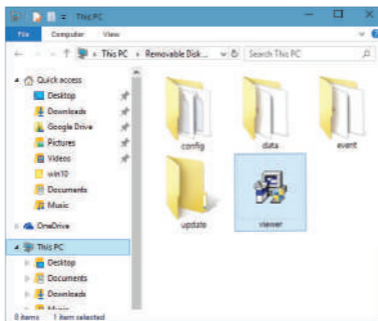

Q What is the G-Sensor?

A G sensor (Gravity Sensor), is a sensor that recognizes movement or tilting of an object due to gravitational action of the Earth.

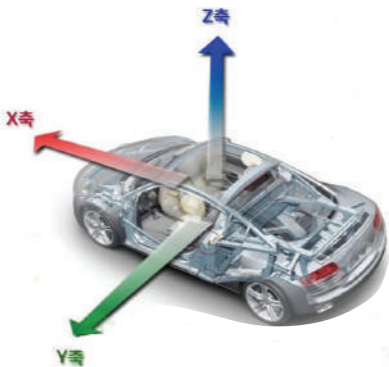

X axis:

Shock and acceleration (+) and deceleration (-) in front and rear are displayed in red.

Y axis:

Shock from left (+) and right (-) side and left and right movement (left turn, right turn) are displayed in green.

Z axis:

Shows the shocks in the top (skyward +) and bottom (ground direction -) in blue.

Q

What kind of recording mode GNET Dash cam have?

A

We have 4 types of recording mode.

Normal Recording		<ul style="list-style-type: none"> - It starts recording when power is connected - Security LED flickers once every 2 seconds
Event Recording	Impact Mode	<ul style="list-style-type: none"> - If there is impact or shock, the REC LED will flicker and record in event mode - After event recording is finished, it will be automatically changed to normal recording mode.
	Parking Mode	<ul style="list-style-type: none"> - When the ACC voltage is released, the parking mode automatically operates in 10 seconds. - It is recorded with 10 frame in order to extend recording time - Security LED flickers every 4 second - If it connects with ACC voltage, it will switch to normal recording mode.
	Motion detection Mode	<ul style="list-style-type: none"> - Under parking mode, it records if there is any movement within a range of 3M - Security LED will blink faster - If the movement finishes, it returns to parking mode again



What is the LBP?



It is equipped with the voltage management function which is installed to protect the battery of the customer who uses the LBP and the dash camera.

LBP is the implication of **Low Battery Power**.

The dash camera is a function that protects the battery of the customer by cutting off the power by oneself. (The purpose of saving the minimum power of the vehicle battery so that the vehicle can be started)

In the case of LBP voltage management system, it can be set in five steps of 11.3V, 11.5V, 11.8V, 12V, and 12.3V, The dash camera will be turned off when you keep it below the reference value for 5 minutes.

	Configurable voltage (V)				
Power OFF	11.3V	11.5V	11.8V	12V	12.3V

Q What is the Parking mode ?

A Parking mode means that if you do not drive the car and the parking condition to record and store for a long time.

In the case of a product which uses a 3-wire constant power cable, if the ACC power is cut off after parking the car, it will enter the parking mode right away.

When entering the parking mode, the dash camera recording frame (FPS) is automatically changed from 30 FPS to **10 FPS**,

In other words, the parking mode can be recording to 3 times than normal (driving) mode.

Q What is the Smart Motion Detection?

A During the Parking:

When parking mode is ON, the dash camera records at 10fps.

When parking is OFF, the dash cam continuous recording at 30fps

When parking mode is ON and motion detection is OFF, the dash camera continuous the recording at 10fps. When parking mode is ON and the motion detection is ON, the dash camera starts the recording at 10fps **only when** there is movement detected.

Q

How can I change the time of device without LCD screen ?

A

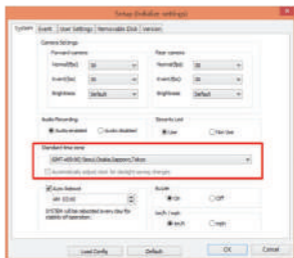
In PC VIEWER, you can enter the **Setting > System > Time** Setting as below

Q My smartphone can not be connected with dashboard camera.

A Depending on the smartphone settings, some smartphones may be disconnected due to weak Internet signals. This is not a problem with the product or smartphone application, please refer to the solution below.

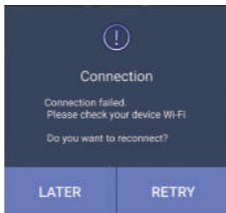

How to check Wi-Fi connection

1. Smart network switch lets you stay connected by switching to available cellular data sources whenever your Wi-Fi connection becomes unstable.

- 1) Swipe down from the top of the screen to pull down the Notification Shade.
- 2) Tap the Settings button in the top right corner of your screen
- 3) Tap Wi-Fi.
- 4) Tap More in the upper right corner of your screen
- 5) Tap Smart network switch.
- 6) Tap on or off in the pop-up message box.

※ Sometimes due to lack of memory of smartphone, smartphone can not be connected with dash camera. If you do not want to connect even after completing the above ways, please clean the memory in the smartphone or quit all running applications.

Q

How to use direct power cable (3 Wired Type)

A

* Black cable : Ground

* Red cable : ACC

(Power source on when key ignition is in accessories or ON position.)

* Yellow cable : VCC (Continued power source.)

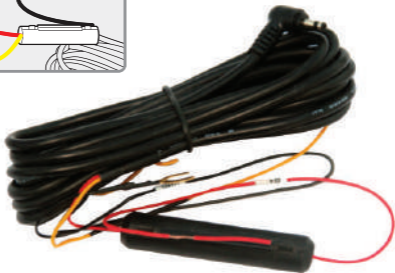
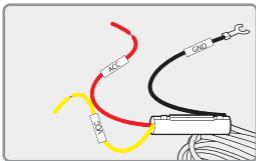

1. Continued recording. even if turn off ignition.

Black cable(Ground) : It should connect to ground in car

Yellow cable(VCC) : It should connect continued power supply of fuse in fuse box
(ex : Emergency light, Hazardous light, Door lock)

Red cable (ACC) : It should connect to power supply of fuse which is operated.
when turn on ignition (ex : cigar light fuse etc)

2. If you don't want to use continued recording of dash cam. when turn off ignition
Black cable(Ground): It should connect to ground in car Twist Yellow cable(VCC)
with Red cable(ACC) as below a picture.

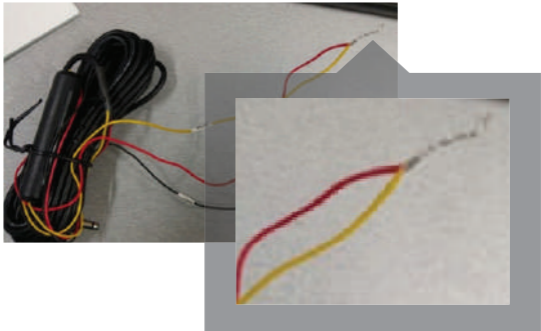

Twisted cable should connect to power supply of fuse which is operated.
when turn on ignition (ex : cigar light fuse etc)



No power (no boot)



1. Check whether the power is applied even after starting the car-> Check the normal operation (Setting → Power management → Check the power off voltage) → The power was cut off by operating LBP.
 2. Unplug the power jack and plug it back in → If it is normal after inserting the jack again → If the problem persists afterwards, send the problem DASHCAM to GNET.
 3. If the main body power LED is turned on → off, if the chip managing power → only the power LED is turned on and DASHCAM is not working normally, send the problem DASHCAM to GNET.
-



Video input error



1. After checking whether the front camera or the rear camera is due to a bad image sensor, send the DASHCAM in question to GNET.



SD card damage



Check the operation after power on / off, check the operation after reinserting SD card, and check if the real-time camera image is normal. It is related to the life of the SD card. If the same symptom appears afterwards, contact the usage time and receive a replacement product within 3 months. If there is no live video, contact GNET.



SD card recognition failure



Check whether the PC is recognized or not, check the operation after reinserting the SD card, contact us for usage time, and receive a replacement product within 3 months.



How to connect your smartphone to Wi-Fi



1. Wi-Fi dongle is used after purchase
3. Install GNET app

3. Select WI-FI menu on the dashcam LCD screen and switch to 'Registration Standby' mode At this time, the voice prompt 'Registered standby mode' appears
(For models without LCD screen, press WI-FI button)
 4. Run GNET app of dashcam registration window and click " Yes" button
 5. Select and connect the model image you are using
-



When the battery power is off and the power is turned off



1. Normal operation

1) Check the type of power cable

1ch models : GN700, G-BLACK

2ch models : G-ON, G-ON2, N2, X2, L2, GDR, IRONMAN, MATMAN, GK,
G-STYX, N2I, N2T, X2I, X2T

3ch models : G-ON3, G-STYX, X3I, GT700 3CH

4ch models : CP440, GT700 4CH

2)Description of LBP

Our dashcam seems to have rebooted the LBP function to protect the car battery. LBP is below the set voltage during parking

The Dashcam automatically shuts off to protect your vehicle's battery.

- 2-wire model: In case of the model you are using, there is no black box start / stop detection line, so a certain voltage must go up and down to divide the driving and parking.
- 3-wire model: In case of the model you are using, there is a Dashcam start-up detection line to check the voltage value at the time of parking and cut off the Dashcam power when it reaches the LCP voltage setting value.

In winter, the weather can get cold and your car's battery performance will weaken, causing frequent dashcam voltage interruptions.



Vehicle battery discharge



1. Always-on connection check
2. Confirm whether it is a 2-wire or 3-wire model (2-wire model does not apply to items 2 and 3 below)
3. Cause of discharge
 - ① In winter, when the weather is cold and the battery performance of the car is weakened, the car may be discharged when the driving time is short. Since the dashcam is a symbiotic car battery, the LBP function is activated to prepare for discharge.
 - ② Setup → Voltage Management → LBP → LBP On Setup → Winter LBP Off Enable → Set LBP Cutoff Voltage to 12.3V
 - ③ If the above setting is still blocked, Voltage Management → Auto Off → Set 3 hours.
 - ④ It is recommended to connect the power cable to the ACC (turn off when the power is turned

If you have to park for 24 hours, please turn off the device. Even if LBP is set, the battery may be discharged during long-term parking.



Recovery Inquiry



1. Saved time Deleted videos cannot be restored because they are overwritten sequentially.
 2. If the user checks the SD card on the computer and accidentally deletes the jdf file in the data / event folder (or if for some reason)
 - ① Just put a SD in the device and boot-> recovered.
 - ② If the user checks the SD card on the computer and accidentally deletes the jdf file in the data / event folder (or if for some reason)
- ※ If you format SD, it can't be recovered.
- ※ If you press the registration standby button (WI-FI BUTTON) for more than 5 seconds, the factory default stored data may be deleted.

WARRANTY CARD

Product	GNET Dash cam	Model	G-ON3
Serial Number		Purchasing Date	
Consumer Information	Name		Tel
	Address		
Seller / Vendor		Tel	
Warranty Period	Dash Camera : 1 Year Micro SD card : 3 months		

* If you require product repair, service and/or support, please contact your local seller or send us an email: info@gnetssystem.com



www.gnetsystem.com/eng

6F Lotte IT Castle II Gasan Digital 2ro 98,

Geumcheon-gu, Seoul, Korea

info@gnetsystem.com

